

# WiFi Assurance Program

## Custom Network Design for

Project Name

Prepared By

Description	Model #	Quantity
OnQ 30" Plastic Enclosure with Hinged Door	ENP3050	1
QnQ Universal Mounting Plate	AC1040	1
Wireless Router 2.4/5GHz AC1200 w/ built-in Wireless Controller XWR-1200	XWR-1200	1

Wi-Fi coverage from the Wireless AP in the First Floor Plan

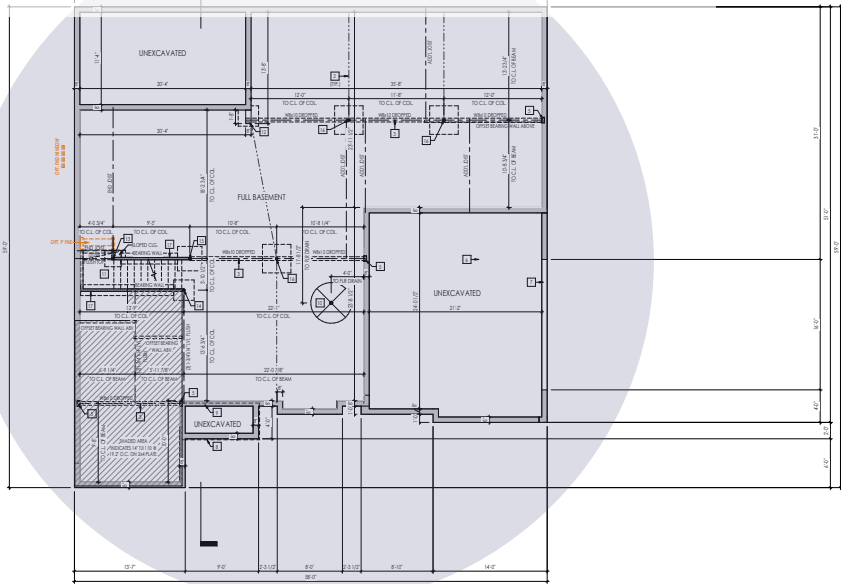

Wi-Fi coverage from the Wireless AP in the First Floor Plan

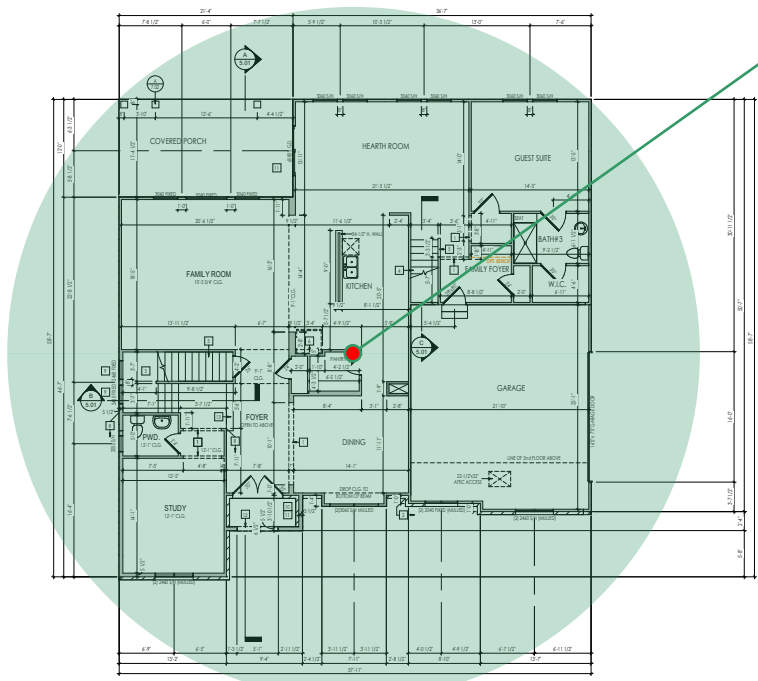
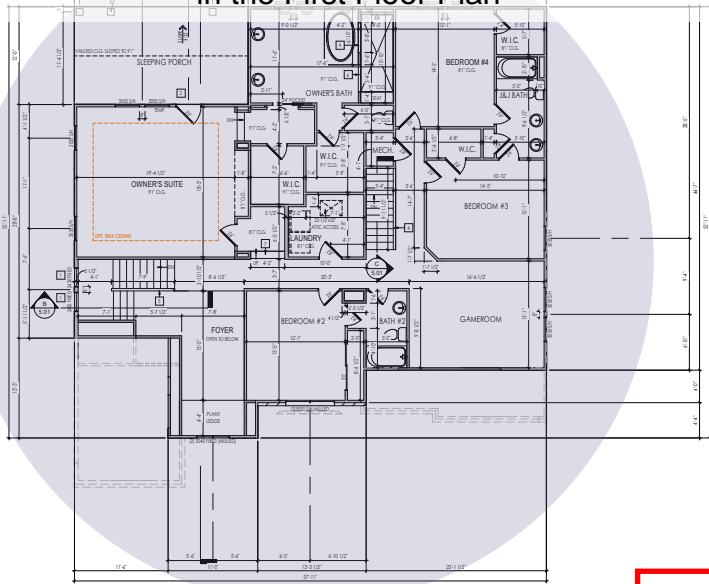



(R)	XWR-1200
4PORT	WiFi
Pantry	
Mounting Plate	
Structured Wiring	



- (R) Router
- (S) Switch
- (AP) Wireless Access Point
- (WC) Wireless Controller

Note: 2.4 GHz WiFi coverage is guaranteed throughout the livable/ conditioned portions of the structure. Varying building materials and obstructions will cause significant degradation in the WiFi signal external to the structure. Thusly this map is not representative of actual external coverage to the home or structure and not covered under our WiFi guarantee.

---

PROJECT

Woodley

---

REVISIONS

NO.	DESCRIPTION	DATE
XXXv1	Design for Bid Basement, First, & Second Floor / WIFI Coverage	1/11/21

---

CUSTOM INTEGRATOR

Drees Homes

---

PROJECT #

0002124

---

TERRITORY SALES MANGER

David Glascock

---

DESIGNED BY

Andres Olvera

---

A-1

# The Best Choice for Your Smart Home Network

---

With the dramatic increase in everyday connected devices, having a powerful network that manages the flow of audio, video, and data has become critical. With that in mind, Luxul:

- Is engineered specifically to support smart home technology networks that smoothly stream video for entertainment and security; audio for pitch-perfect sound; and accurate data for thermostats, shades, and lighting control.
- Is built for professional installers who know how to configure and optimize networks.
- Provides a network that can handle the everyday demand on bandwidth and is built with the horsepower to run today's technology and beyond.
- Wireless coverage everywhere you need it, with the ability to seamlessly move your device between Access Points without dropping off the network.

## Warranty

Luxul offers free software updates plus a three-year hardware warranty on all Luxul network products when the network components are purchased from and installed by an Authorized Luxul Dealer.



# Internet protection for your home buyers

Provide the added benefit of content management to your home buyers with Router Limits, built-in to Luxul Epic routers. With Router Limits, home owners are able to set boundaries on what websites are off limits, what times the Internet should be available, and track browsing history.



## Manage Screen Time

Set Internet access schedules that fit the needs of each person. For example, filter social media for employees during the workday, or shut off the kids' access to the Internet completely during dinner and at bedtime.



## Filter Content

An extensive library of filters include categories like Games, Social Media, and Offensive Content, as well as popular sites and apps like Facebook, Netflix, and Snapchat. Filters can be customized to your exact needs.



## Track Browsing History

View web use and browsing history data right at your fingertips. Now you can see what's happening on your network, even when you're not there.

## XWR-1200

### WHAT THIS PRODUCT DOES:

Featuring high performance 802.11ac 2x2 MIMO technology, the XWR-1200 is an affordable option for delivering an excellent Wi-Fi experience. Plus, it has a built-in wireless controller with Luxul's exclusive Roam Assist™ capability—allowing you to easily add up to two more wireless APs for a seamless whole-home Wi-Fi experience.

- ▶ Adds Powerful Routing and Wi-Fi Coverage to Homes or Small Businesses
- ▶ Easily Expands Wi-Fi Network with up to 2 Additional APs
- ▶ Enables VPN Remote Access to the Network
- ▶ Allows Secure Guest Networking

### FEATURES:

- ▶ Seamless Roaming with Luxul Roam Assist™
- ▶ 2x2 MIMO
- ▶ High Power for Extended Signal Range
- ▶ Wireless Data Transfers of up to 1200Mbps
- ▶ Concurrent Dual-Band Wireless AC
- ▶ 5GHz Beamforming
- ▶ Virtual Private Network (VPN)
- ▶ Secure Guest Networking
- ▶ Virtual Local Area Network (VLAN) Support
- ▶ Quality of Service (QoS)
- ▶ Network Security and Firewall
- ▶ 1 WAN and 4 LAN Gigabit Ports
- ▶ USB 2.0 Port
- ▶ Three Year Limited Warranty

## Dual-Band Wireless AC1200 Gigabit Router



### XWR-1200 TECHNICAL SPECIFICATIONS

#### Hardware Features

<b>Standards Compliance</b>	2.4GHz: IEEE802.11n, IEEE802.11g, IEEE 802.11b; 5.xGHz: IEEE 802.11n, IEEE 802.11a; 802.11ac
<b>Interface</b>	▶ One 10/100/1000M WAN Port ▶ Four 10/100/1000M LAN Ports ▶ One USB 2.0 Port
<b>Antenna</b>	Two Dual-Band Detachable Omni-Directional Antennas
<b>Button</b>	Power Button/Reset Button
<b>Power</b>	Input: 12V/2A DC Power Jack
<b>Power Consumption</b>	18W Max
<b>Environmental Temperatures</b>	0-40c
<b>Dimensions LxWxH in. (mm)</b>	8.1"x5.6"x1.5" (206x142x38)
<b>LEDs</b>	Power, SYS, USB, WAN, LAN (4), 5GHz, 2.4GHz

#### Wireless and Other Features

<b>Wireless Speed</b>	▶ 2.4GHz: 300Mbps; ▶ 5GHz: 866Mbps.
<b>Frequency</b>	Concurrent 2.4GHz and 5GHz
<b>Wireless Security</b>	WPA-PSK/WPA2-PSK, WPA/WPA2
<b>Operating Modes</b>	Wireless Router, Wireless Controller
<b>Other Functions and Features</b>	▶ Quality of Service (QoS) ▶ Guest Network Support ▶ VPN Support: PPTP, L2TP, IPSEC ▶ Port Forwarding ▶ MAC Address Cloning ▶ DHCP Server, Client, Address Reservation ▶ Backup & Restore Configurations ▶ Firmware Upgradeable via Browser ▶ Secure Remote Access via VPN
<b>Certifications</b>	CE, FCC, RoHS, IC, RCM

#### Warranty:

- ▶ 3 Year Limited Warranty

#### Requirements

- ▶ Suitable Network Devices
- ▶ Ethernet Cable
- ▶ Internet Connection to View Documentation

#### Package Contents

- ▶ One: XWR-1200 Dual-Band Wireless AC1200 Gigabit Router
- ▶ One: Ethernet Cable
- ▶ One: Power Adapter
- ▶ One: Quick Install Guide
- ▶ Two: Dual-Band Omni-Directional Antennas

All references to speed are for comparison purposes only. Product specifications, size and shape are subject to change without notice, and actual product appearance may differ from that depicted herein.

## XAP-810

### WHAT THIS PRODUCT DOES:

The XAP-810 offers forefront 802.11ac 2x2 dual-band technology and 5 GHz beamforming, cost-effective Wi-Fi. The sleek design allows for unobtrusive mounting on a ceiling, wall or other flat surface--making it a great choice for stretching budgets and delivering coverage to smaller spaces. It is compatible with Luxul Wireless Controllers and can be used standalone or as part of a multi-AP deployment. Installation is simple, requiring only a single ethernet cable delivering data and power.

- ▶ Concurrent dual-band 802.11ac Wi-Fi
- ▶ 5 GHz beamforming
- ▶ Secure guest networking
- ▶ Simple and discreet installation

### FEATURES:

- ▶ AC1200 2x2 dual-band MIMO
- ▶ Up to 4 SSIDs per band (8 total)
- ▶ Compatible with the Luxul Roam Assist Wireless Controllers
- ▶ Single cable installation with PoE (Injector included)
- ▶ Installs on ceilings, walls, or use as a desktop AP
- ▶ 3-year limited warranty

## High Power AC1200 Dual-Band Wireless AP



### XAP-810 TECHNICAL SPECIFICATIONS

Hardware Features	
<b>Standards Compliance</b>	IEEE, 802.11b/g/n, 802.11a/n/ac, 802.3at
<b>Interface</b>	Two 10/100/1000M Ports
<b>Antenna</b>	Two Dual-Band Antennas
<b>Button</b>	Reset button
<b>Power</b>	PoE (Injector Included)
<b>Power Consumption</b>	12W Avg
<b>Max Power Consumption</b>	17W
<b>Operating Temperatures</b>	0-50°C
<b>Dimensions WxHxD in. (mm)</b>	6.25"x6.25"x1.75" (158.75 x158.75 x44.45)
<b>Weight lbs (kg)</b>	.95 (.44)
<b>LEDs</b>	Power, 2.4GHz, 5GHz (Can be turned Off/On Via User Interface)
Wireless and Other Features	
<b>Frequency</b>	Concurrent 2.4GHz and 5GHz with Beamforming
<b>Wireless Speed</b>	▶ 2.4GHz: 300Mbps; ▶ 5GHz: 866Mbps
<b>Wireless Security</b>	WPA-PSK, WPA2-PSK, WPA/WPA2
<b>Operating Modes</b>	Wireless AP
<b>Other Functions and Features</b>	▶ Remote Web Management ▶ System Logging ▶ Backup & Restore Configurations ▶ Firmware Upgradeable via UI
<b>Certifications</b>	CE, FCC, RoHS, IC, RCM

All references to speed are for comparison purposes only. Product specifications, size and shape are subject to change without notice, and actual product appearance may differ from that depicted herein.

### Warranty:

- ▶ 3-year limited warranty

### Minimum Requirements

- ▶ Web browser
- ▶ Ethernet cable
- ▶ Internet connection to view documentation online

### Package Contents

- ▶ High power AC1200 dual-band AP
- ▶ Mounting kit
- ▶ Rubber feet
- ▶ PoE injector and power adapter
- ▶ Quick install guide

## Luxul Easy Setup App

Quickly and easily setup a basic Luxul network, all from the ease of your phone

### WHAT THIS PRODUCT DOES:

The Easy Setup App for iPhone and Android mobile devices allows dealers to quickly and easily install a Luxul wireless router while also ensuring the essential settings are properly configured, resulting in a more secure and effective network for end customers. The app allows you to discover the wireless router, update to the latest firmware, set the administrator password, set the wireless SSID and passphrase for both the 2.4GHz and 5GHz networks, and add up to 2 additional access points to the router's embedded controller.

### FEATURES:

- ▶ Install a Luxul wireless router and up to 2 wireless access points
- ▶ Ensure properly configured network
- ▶ Use from mobile phone
- ▶ Free download

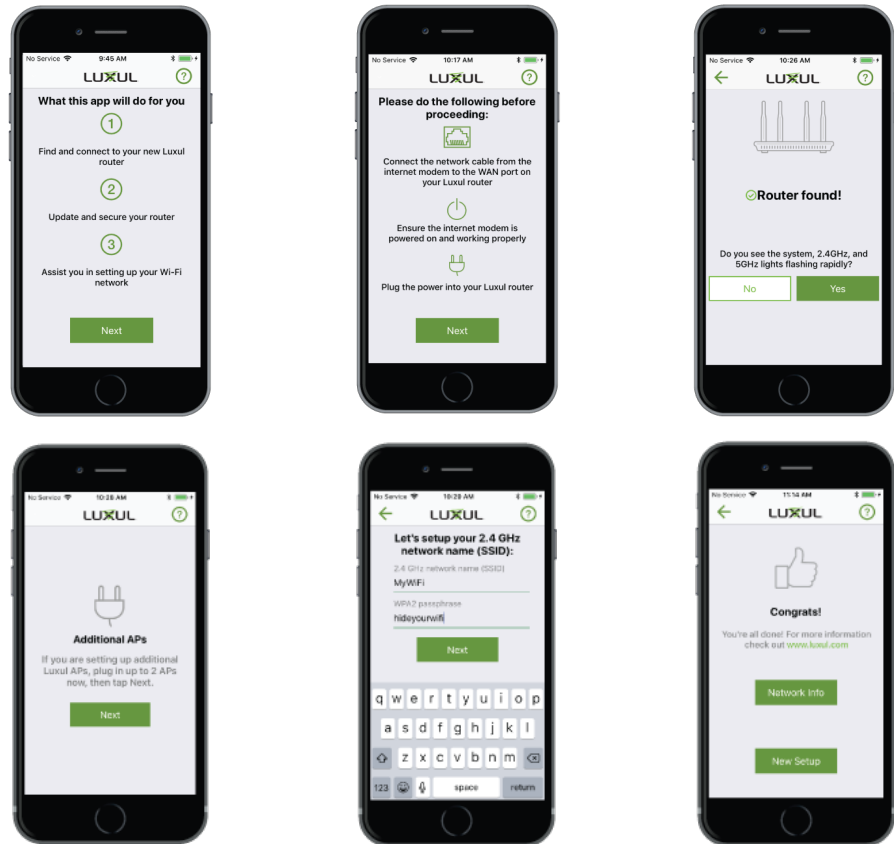

### REQUIREMENTS

#### Minimum System Requirements

	Android	iOS
Minimum Mobile OS Requirement	Android 6.0 (Marshmallow) or newer	iOS 11 or newer
Phone	Most Android phones running 6.0 or newer	iPhone 5s or newer

#### Compatible Luxul Products

	Epic 3	XWR-1200
Type	Wireless router	Wireless router
Minimum Router Firmware Requirement	6.3.0 or newer	6.3.0 or newer

# Universal Mounting Plate

## AC1040

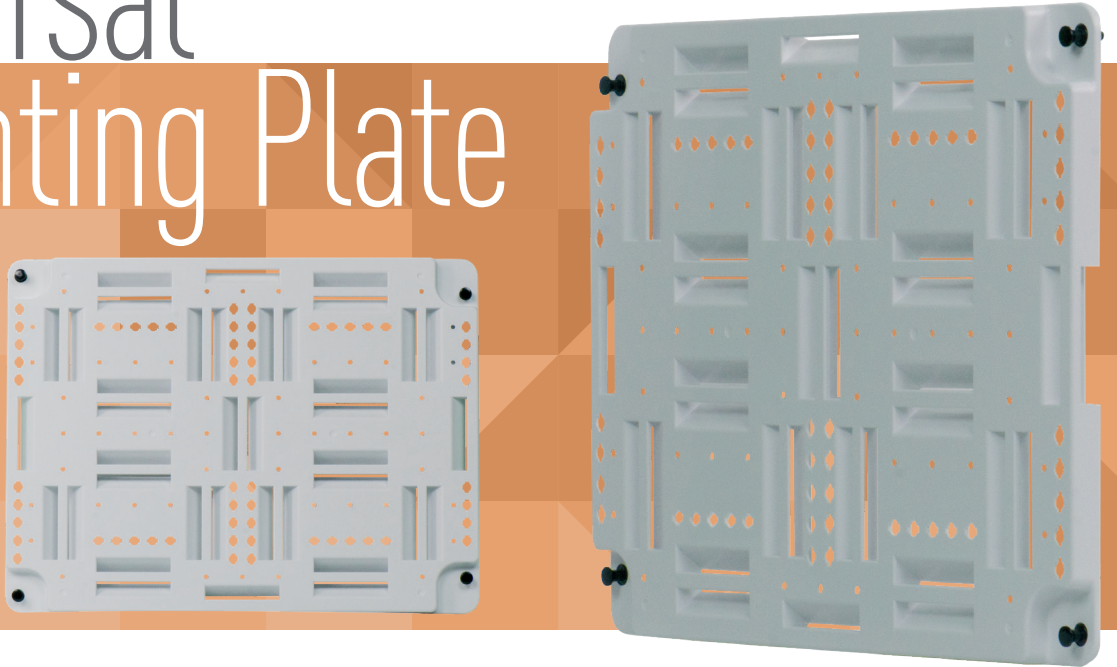

The Universal Mounting Plate is constructed of Wi-Fi transparent ABS Plastic and designed to securely mount a variety of 3rd party devices into the On-Q plastic or metal structured wiring enclosure. It contains vertical and horizontal lancing locations that can be utilized with the 4 feet of included Velcro to strap down large devices like

an ISP Modem / Router. Screw holes are strategically placed throughout for affixing devices like a fiber optic network unit (ONU), cable amplifier or cable splitter. When paired with a Wi-Fi transparent On-Q Plastic Enclosure, wireless devices can easily be secured inside the enclosure without compromising wireless performance.

### FEATURES & BENEFITS

- Allows 3rd party wired and wireless devices to be secured within structured wiring enclosure
- Vertical and horizontal lancing locations provide a variety of mounting options
- Strategically placed screw holes allow devices to be securely affixed within enclosure
- Universal mounting holes accept 3rd party modules to maximize compatibility
- Includes (4) plungers and grommets and 4 feet of velcro strapping
- Constructed of durable Wi-Fi transparent ABS Plastic

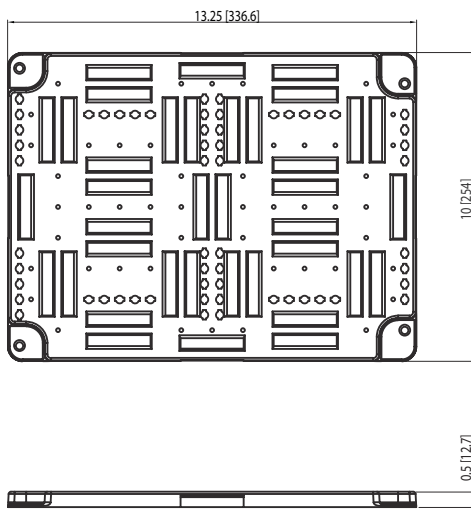





## Centralized Distribution for Wired & Wireless Low Voltage Systems

**20": ENP2050, ENP2060, ENP2060-5, ENP2080, ENP2080-5**

**30": ENP3050, ENP3060, ENP3060-5, ENP3080, ENP3080-5**

**42": ENP4250, ENP4260, ENP4260-5, ENP4280, ENP4280-5**

**Trim Rings: ENP2001, ENP3001, ENP4201**

**Accessories: AC1040, AC1041, AC1035-20**

This enclosure secures both wired structured wiring systems and wireless networking equipment in a professional, out-of-sight installation.

Order as a complete assembly containing the enclosure and hinged door, a-la-carte, or in bulk to efficiently meet the requirements of your project

### Enclosures: Features & Benefits

- **Wireless Transparent Material** – UL-rated ABS plastic allows wireless devices such as access points to secure in the cabinet without degrading network performance.
- **Stackable** – Enclosures and doors are each neatly stackable to efficiently ship and warehouse.
- **Surface or Flush Mounting** – Mounts flush to the stud bay with staggered tabs that allow side-by-side installations of multiple enclosures.
- **UL Rated** – Meets or exceeds the standards of UL Standard 2416. Specified for non-fire rated walls.
- **Universal Mounting Grid** – Compatible with video, voice and data distribution modules from multiple manufacturers. Ask us for our up-to-date compatibility list.
- **Extensive Venting** – Provides superior heat dispersion for powered devices mounted in the enclosure.
- **Extra Depth** – Protruded door adds 1.2" (30mm) of enclosure depth for compatibility with more third party devices such as uninterruptable power supplies (UPS).
- **Conceals Drywall Cutout** – Extended door circumference conceals the drywall cutout for a professional finish.
- **Layered Latch** – Holds the door shut and flush to the drywall without the need of a lock. Locking can be accommodated with the provided screw holes.



**Enclosure includes two electrical knockouts on the bottom and five 2" (51mm) cable knockouts on top. 2" rubber grommets are available as an accessory item.**

### Compliance

- UL 985, Household Fire-Warning System Units. ULC-S545, Residential Fire Warning System Control Units
- UL 1023, Household Burglar-Alarm System Units. CAN/ULC/ORD-C1023, Household Burglar Alarm System Units
- UL 2416, Audio/Video, Information and Communication Technology Equipment Cabinet, Enclosure and Rack Systems
- UL60950-1 & CAN/CSA C22.2 No. 60950-01-07, Information Technology Equipment, Including Electrical Business Equipment
- RoHS Compliant

## Technical Information

### Enclosure Specifications

	20" Enclosure	30" Enclosure	42" Enclosure
Material	ABS Plastic	ABS Plastic	ABS Plastic
Color	White (Paintable*)	White (Paintable*)	White (Paintable*)
Specified Temperature	32°F - 122°F, 0°C - 50°C	32°F - 122°F, 0°C - 50°C	32°F - 122°F, 0°C - 50°C
Unit Weight	4.5 Lbs 2.04kg	6.17 Lbs 2.8kg (ENP3050)	8.64 Lbs 3.2kg (ENP4250)
Shipping Weight	6.5 Lbs 2.95kg	8.7 Lbs 3.95kg (ENP3050)	12.2 Lbs 5.5 kg (ENP4250)
Paintable*	Rust-Oleum Paint for Plastic or equivalent	Rust-Oleum Paint for Plastic or equivalent	Rust-Oleum Paint for Plastic or equivalent

## Dimensions – Enclosures

### 20" Enclosure

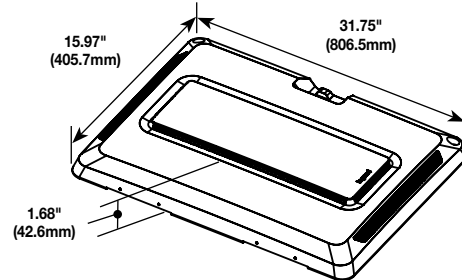
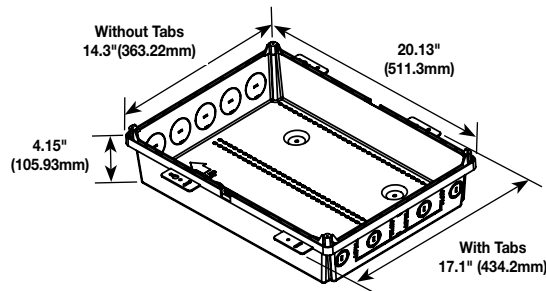

### 30" Enclosure

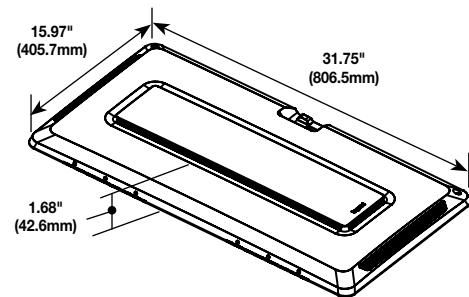
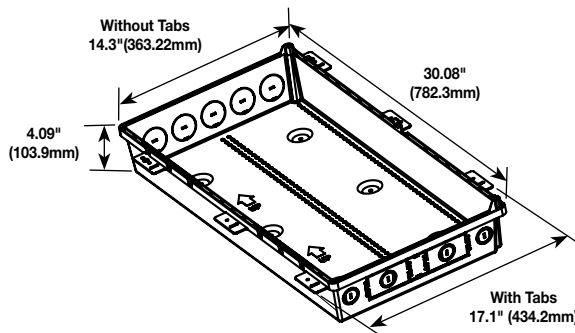

### 42" Enclosure

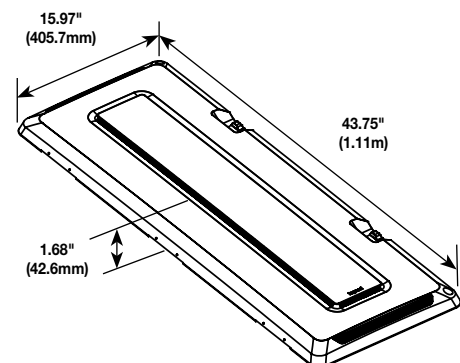
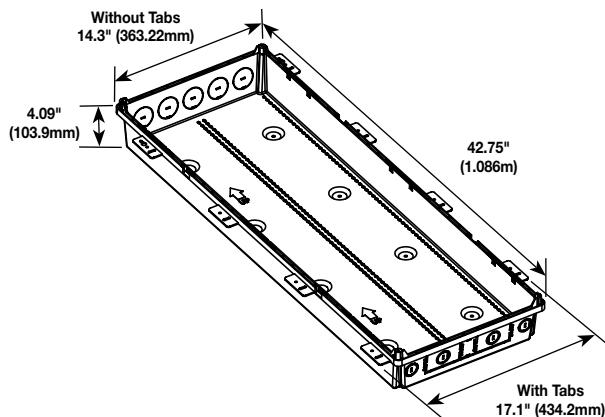

## Technical Information

### Trim Rings Specifications

	20" Trim Ring	30" Trim Ring	40" Trim Ring
Material	ABS Plastic	ABS Plastic	ABS Plastic
Color	White (Paintable*)	White (Paintable*)	White (Paintable*)
Specified Temperature	32°F - 122°F, 0°C - 50°C	32°F - 122°F, 0°C - 50°C	32°F - 122°F, 0°C - 50°C
Unit Weight	0.5 Lbs 0.227 kg	1 Lb 0.454kg	1 Lb 0.454kg
Shipping Weight	0.5 Lbs 0.227 kg	1 Lb 0.454kg	1 Lb 0.454kg
Paintable*	Rust-Oleum Paint for Plastic or equivalent	Rust-Oleum Paint for Plastic or equivalent	Rust-Oleum Paint for Plastic or equivalent

### Dimensions – Trim Rings

#### ENP2001 – Plastic 20" Trim Ring

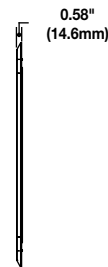
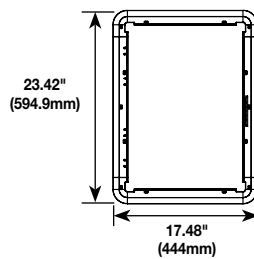
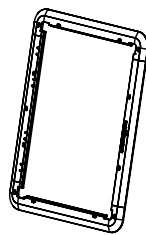

#### ENP3001 – Plastic 30" Trim Ring

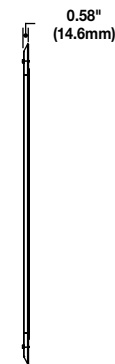
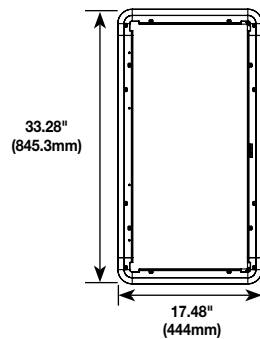
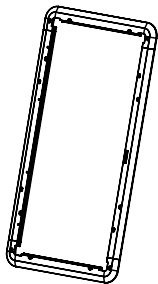

#### ENP4201 – Plastic 42" Trim Ring

