





WiFi Assurance Program



Custom Network Design for

Project Name

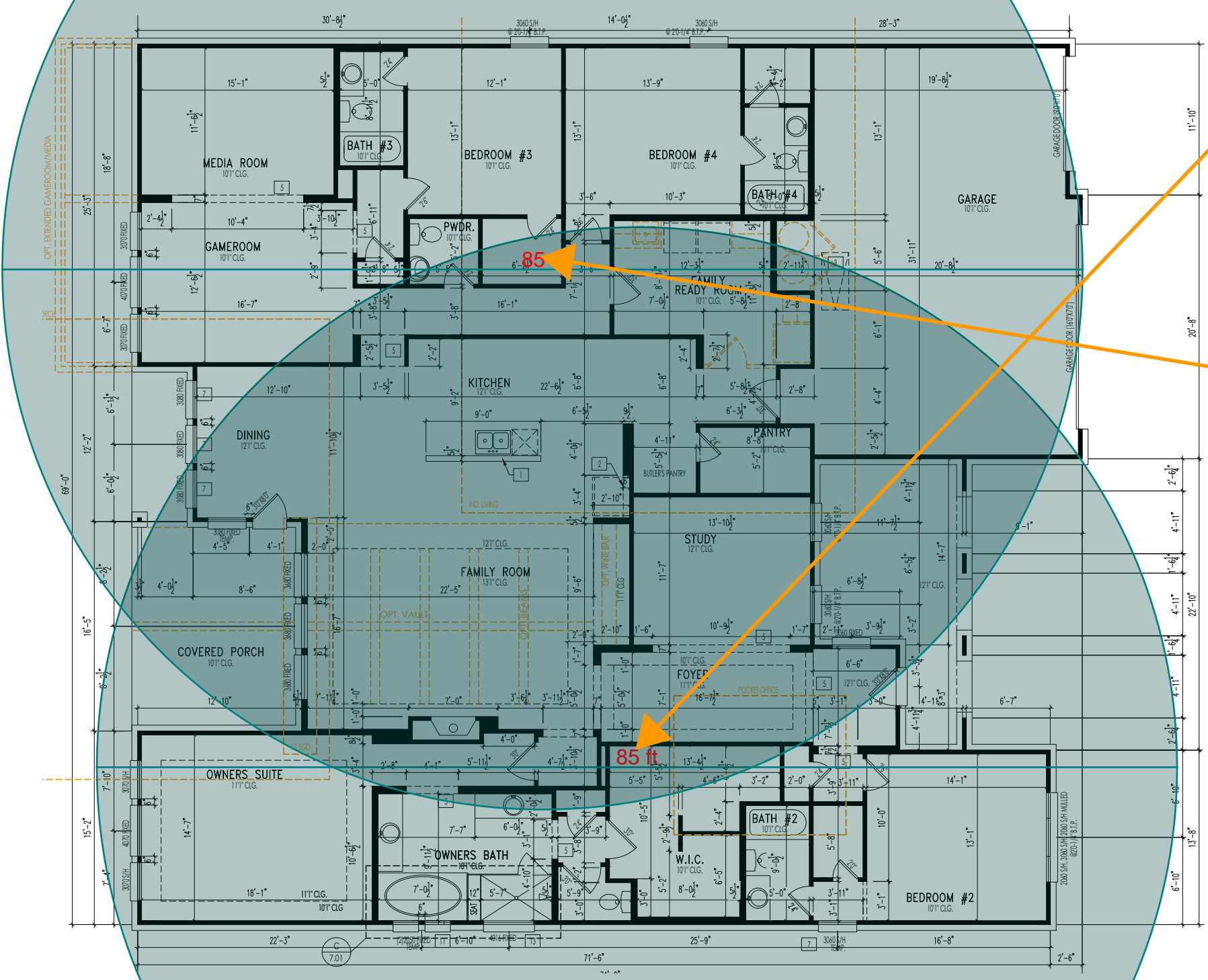

Prepared By

Description	Model #	Quantity
 Dual-Band AC3100 Wireless Router w/Domotz	XWR-3150	1
 High TX Power AC1900 Dual-Band WAP	XAP-1510	1
 OnQ 30" Plastic Enclosure with Hinged Door	ENP3050	1
 QnQ Universal Mounting Plate	AC1040	1



-  Router
-  Switch
-  Wireless Access Point
-  Wireless Controller

Note: 2.4 GHz WiFi coverage is guaranteed throughout the livable/ conditioned portions of the structure. Varying building materials and obstructions will cause significant degradation in the WiFi signal external to the structure. Thusly this map is not representative of actual external coverage to the home or structure and not covered under our WiFi guarantee.

PROJECT		
Leighten Model		
REVISIONS		
NO.	DESCRIPTION	DATE
DHv1	Design for Bid	01/25/23
First Floor / WIFI Coverage		
CUSTOM INTEGRATOR		
Drees Homes		
PROJECT #		
0003372		
TERRITORY SALES MANGER		
DESIGNED BY		
Kelly Draney		
A-1		

The Best Choice for Your Smart Home Network

With the dramatic increase in everyday connected devices, having a powerful network that manages the flow of audio, video, and data has become critical. With that in mind, Luxul:

- Is engineered specifically to support smart home technology networks that smoothly stream video for entertainment and security; audio for pitch-perfect sound; and accurate data for thermostats, shades, and lighting control.
- Is built for professional installers who know how to configure and optimize networks.
- Provides a network that can handle the everyday demand on bandwidth and is built with the horsepower to run today's technology and beyond.
- Wireless coverage everywhere you need it, with the ability to seamlessly move your device between Access Points without dropping off the network.

Warranty

Luxul offers free software updates plus a three-year hardware warranty on all Luxul network products when the network components are purchased from and installed by an Authorized Luxul Dealer.



Internet protection for your home buyers

Provide the added benefit of content management to your home buyers with Router Limits, built-in to Luxul Epic routers. With Router Limits, home owners are able to set boundaries on what websites are off limits, what times the Internet should be available, and track browsing history.



Manage Screen Time

Set Internet access schedules that fit the needs of each person. For example, filter social media for employees during the workday, or shut off the kids' access to the Internet completely during dinner and at bedtime.



Filter Content

An extensive library of filters include categories like Games, Social Media, and Offensive Content, as well as popular sites and apps like Facebook, Netflix, and Snapchat. Filters can be customized to your exact needs.



Track Browsing History

View web use and browsing history data right at your fingertips. Now you can see what's happening on your network, even when you're not there.

EPIC 3

WHAT THIS PRODUCT DOES:

Featuring advanced 4x4 MU-MIMO (Wave 2) technology, the EPIC 3 with Domotz represents the latest in Wi-Fi technology and remote management for a superior Wi-Fi experience. Roaming is solved with its built-in wireless controller by our exclusive Roam Assist™ technology—allowing you to easily add up to two more wireless APs for a seamless Wi-Fi experience.

- ▶ Adds powerful routing and Wi-Fi coverage to larger homes or small businesses
- ▶ Easily expand Wi-Fi network with up to 2 additional APs
- ▶ Enables VPN remote access to the network
- ▶ Manage networks from anywhere using built-in Domotz remote management

FEATURES:

- ▶ Roaming solved with Luxul Roam Assist™
- ▶ 4x4 MU-MIMO (Wave 2)
- ▶ High power for extended signal range
- ▶ Built-in remote management (Domotz)*
- ▶ Parental controls with Router Limits*
- ▶ Concurrent dual-band wireless AC
- ▶ 2.4 and 5GHz beamforming
- ▶ Virtual private network (VPN)
- ▶ Secure guest networking
- ▶ Virtual local area network (VLAN) support
- ▶ Quality of service (QoS)
- ▶ Network security and firewall
- ▶ 1 WAN and 4 LAN gigabit ports
- ▶ 1 USB 3.0 port
- ▶ 3-year limited warranty

Dual-Band Wireless AC3100 Gigabit Router w/ Domotz & Router Limits



XWR-3150 TECHNICAL SPECIFICATIONS

Hardware Features	
Standards Compliance	2.4GHz: IEEE802.11n, IEEE802.11g, IEEE 802.11b; 5.xGHz: IEEE 802.11n, IEEE 802.11a; 802.11ac IEEE802.3, IEEE802.3u, IEEE802.3ab
Interface	▶ One 10/100/1000M WAN Port (Auto MDI/MDIX) ▶ Four 10/100/1000M LAN Ports (Auto MDI/MDIX) ▶ One USB 3.0 Port
Antenna	Four 5dBi Detachable Omni-Directional Antennas
Button	Power Button/Reset Button
Power	Input: 12VDC @ 3A
Max Power Consumption	35W
Dimensions LxWxH in. (mm)	9.3"x7"x1.65" (236x178x42)
Weight lbs (kg)	1.80 (.82)
LEDs	Power, SYS, USB, WAN, LAN (4), 5GHz, 2.4GHz
Wireless and Other Features	
Wireless Speed	▶ 2.4GHz: 1000Mbps; ▶ 5GHz: 2167Mbps.
Frequency	Concurrent 2.4GHz and 5GHz
Wireless Security	WPA/WPA2-PSK, WPA/WPA2, AES
Operating Modes	Wireless Router, Wireless AP, Wireless Controller
Other Functions and Features	▶ Remote management w/ Domotz* ▶ Router Limits* ▶ Roam Assist™ ▶ Quality of service (QoS) ▶ Guest network support ▶ VPN support: PPTP, L2TP, IPSEC ▶ Port forwarding ▶ DHCP server, client, address reservation ▶ Backup & restore configurations ▶ Firmware upgradeable via browser ▶ Secure remote access via VPN
Certifications	CE, FCC, RoHS, IC, RCM

All references to speed are for comparison purposes only. Product specifications, size and shape are subject to change without notice, and actual product appearance may differ from that depicted herein.

Warranty:

- ▶ 3-year limited warranty

Requirements

- ▶ Suitable network devices
- ▶ Ethernet cable
- ▶ Internet connection to view documentation

Package Contents

- ▶ Dual-band wireless AC3100 gigabit router
- ▶ Ethernet cable
- ▶ Power adapter
- ▶ Quick install guide
- ▶ 5dBi omni-directional antenna (4)



XWR-3150

Note: If you are currently on a firmware version earlier than 6.1.8 please refer to the "Known Limitations" under Firmware Version 6.1.8 before updating to the current version.

Release Firmware Version 6.7.2 - Recommended Update

Note: It is NOT recommended to update the firmware wirelessly as damage to the router may occur.

Issues Resolved:

- Increased Luxul ProWatch reliability of switch port information displayed from Luxul ProWatch Integrated switches.
- Luxul ProWatch now correctly displays the port information from the XMS-7048P managed switch.

Release Firmware Version 6.7.1

Note: It is NOT recommended to update the firmware wirelessly as damage to the router may occur.

Enhancements:

- Adds support for Luxul ProWatch remote monitoring & management application (coming soon)
- Fixes static leases table sorting
- Minor UI improvements and fixes

Known Limitations:

- For known limitations, please see "Known Limitations" notes under previous firmware version

Release Firmware Version 6.6.0

Note: It is NOT recommended to update the firmware wirelessly as damage to the router may occur.

Enhancements:

- You will now be required to change the default admin password upon first login. The new password cannot be the existing default password. This is to comply with new security laws for California & Oregon that go into effect January 1, 2020
- When router is in a factory default state, the WAN port will be disabled until the admin password has been changed (see above)
- On first time setup or after factory default the wireless network is now secured with the following password settings:
 - Passphrase = "luxulwifi"
 - Encryption = WPA2
- Minor UI updates and improvements

Downloads

Current Version:

- [Firmware Version 6.7.2](#)

Previous Version:

- [Firmware Version 6.7.1](#)
- [Firmware Version 6.6.0](#)
- [Firmware Version 6.5.1](#)
- [Firmware Version 6.4.2](#)
- [Firmware Version 6.3.1](#)

For questions regarding previous firmware versions:
[contact support](#)

XAP-1510

WHAT THIS PRODUCT DOES:

The XAP-1510 combines leading-edge 802.11ac technology with high output power to deliver outstanding dual-band Wi-Fi performance. The sleek design allows for unobtrusive mounting on a ceiling, wall or other flat surface—making it a great choice for maximizing coverage in both Residential and Commercial environments. It is compatible with the XWC-1000 Wireless Controller and can be used standalone or as part of a multi-AP deployment. Installation is simple, requiring only a single Ethernet cable that delivers both power and data through the integrated PoE+ port.

- ▶ High Performance 802.11ac Wi-Fi (up to 1900Mbps)
- ▶ Concurrent Dual-Band with Beamforming
- ▶ Compatible with XWC-1000 Wireless Controller
- ▶ Great for Streaming Media and Other Demanding Applications
- ▶ Secure Guest Networking
- ▶ Simple and Discreet Installation

FEATURES:

- ▶ High Output Power for Maximum Coverage
- ▶ Beamforming for Optimal Wi-Fi Performance
- ▶ Data Transfers of up to 1900Mbps
- ▶ Concurrent Dual-Band
- ▶ Compatible with the Luxul XWC-1000 Wireless Controller
- ▶ VLAN Support for Creating a Secure Guest Network
- ▶ Up to 4 SSIDs per Band for a total of 8 SSIDs
- ▶ Single Cable Installation with PoE (Injector included)
- ▶ Installs on Ceiling or Wall; Or Use as a Desktop AP
- ▶ Three Year Limited Warranty

High Power AC1900 Dual-Band Wireless AP



XAP-1510 TECHNICAL SPECIFICATIONS

Hardware Features	
Standards Compliance	IEEE, 802.11b/g/n, 802.11a/n/ac, 802.3at
Interface	Two 10/100/1000M Ports
Antenna	Three Dual-Band Antennas
Button	Reset button
Power	PoE (Injector Included)
Power Consumption	10W Idle 25.3W Peak
Environment Temperatures	0-50C°
Dimensions WxHxD in. (mm)	7.25"x7.25"x2" (184.15 x184.15 x50.8)
Weight lbs (kg)	1.5 (.68)
LEDs	Power, 2.4GHz, 5GHz (Can be turned Off/On Via User Interface)
Wireless and Other Features	
Frequency	Concurrent 2.4GHz and 5GHz with Beamforming
Wireless Speed	<ul style="list-style-type: none"> ▶ 2.4GHz: 600Mbps; ▶ 5GHz: 1.3Gbps
Wireless Security	WPA-PSK, WPA2-PSK, WPA/WPA2
Operating Modes	Wireless AP
Other Functions and Features	<ul style="list-style-type: none"> ▶ Remote Web Management ▶ System Logging ▶ Backup & Restore Configurations ▶ VLAN/Guest Network Support ▶ Up to 4 SSIDs per Band for a total of 8 SSIDs ▶ Firmware Upgradeable via UI ▶ XWC-1000 Wireless Controller Compatible
Certifications	CE, FCC, RoHS

Warranty:

- ▶ Three Year Limited Warranty

Minimum Requirements

- ▶ Web Browser
- ▶ Ethernet Cable
- ▶ Internet Connection to View Documentation Online

Package Contents

- ▶ One: High Power AC1900 Dual-Band AP
- ▶ One: Mounting Bracket and Hardware
- ▶ One: PoE Injector and Power Adapter
- ▶ One: Quick Install Guide

All references to speed are for comparison purposes only. Product specifications, size and shape are subject to change without notice, and actual product appearance may differ from that depicted herein.



XAP-1510

Note: It is NOT recommended to update the firmware wirelessly.

Release Firmware Version 8.2.5 - Recommended Update

Enhancements:

- Improves Luxul ProWatch discovery by updating the device hostname to be unique

Known Limitations:

- When using Safari on macOS, in some cases when changing the admin password you are not redirected to a new login screen. Solution: Close the current tab/browser, open a new tab/browser session and browse to the new IP address of the device. This fixes the issue and will allow you to move forward.
- Additional SSID character support is limited to the Quick Setup page and the wireless profiles pages will be updated in a future release.

Release Firmware Version 8.2.2

Enhancements:

- Adds support for Luxul ProWatch remote monitoring & management application
- Minor UI improvements and fixes

Known Limitations:

- When using Safari on macOS, in some cases when changing the admin password you are not redirected to a new login screen. Solution: Close the current tab/browser, open a new tab/browser session and browse to the new IP address of the device. This fixes the issue and will allow you to move forward.
- Additional SSID character support is limited to the Quick Setup page and the wireless profiles pages will be updated in a future release.

Downloads

- [Upgrade Instructions](#)

Current Version:

- [Firmware Version 8.2.5](#)

Previous Version:

- [Firmware Version 8.2.2](#)

Copyright and Trademark Notices

No part of this document may be modified or adapted in any way, for any purposes without permission in writing from Luxul. The material in this document is subject to change without notice. Luxul reserves the right to make changes to any product to improve reliability, function, or design. No license is granted, either expressly or by implication or otherwise under any Luxul intellectual property rights. An implied license only exists for equipment, circuits and subsystems contained in this or any Luxul product.

© Copyright 2020 Legrand AV Inc. All rights reserved. The name Luxul, the Luxul logo, the Luxul logo mark and Simply Connected are all trademarks and or registered trademarks of Legrand AV Inc.

All other trademarks and registered trademarks are property of their respective holders.

Luxul Easy Setup App

Quickly and easily setup a basic Luxul network, all from the ease of your phone

WHAT THIS PRODUCT DOES:

The Easy Setup App for iPhone and Android mobile devices allows dealers to quickly and easily install a Luxul wireless router while also ensuring the essential settings are properly configured, resulting in a more secure and effective network for end customers. The app allows you to discover the wireless router, update to the latest firmware, set the administrator password, set the wireless SSID and passphrase for both the 2.4GHz and 5GHz networks, and add up to 2 additional access points to the router's embedded controller.

FEATURES:

- ▶ Install a Luxul wireless router and up to 2 wireless access points
- ▶ Ensure properly configured network
- ▶ Use from mobile phone
- ▶ Free download

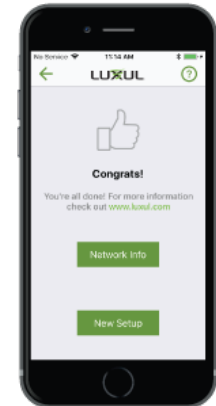
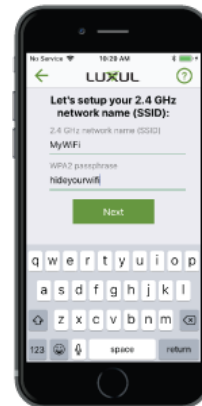
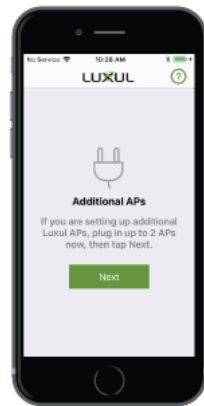
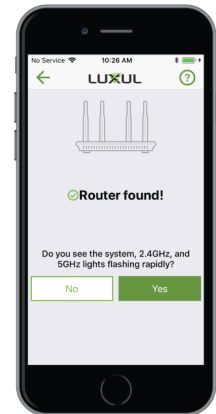
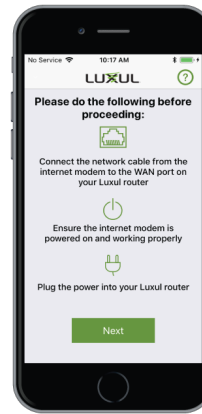
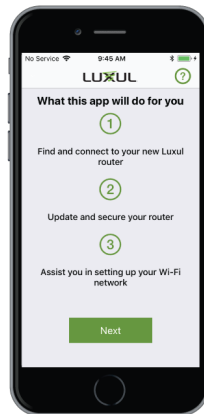

REQUIREMENTS

Minimum System Requirements

	Android	iOS
Minimum Mobile OS Requirement	Android 6.0 (Marshmallow) or newer	iOS 11 or newer
Phone	Most Android phones running 6.0 or newer	iPhone 5s or newer

Compatible Luxul Products

	Epic 3	XWR-1200
Type	Wireless router	Wireless router
Minimum Router Firmware Requirement	6.3.0 or newer	6.3.0 or newer

Universal Mounting Plate

AC1040

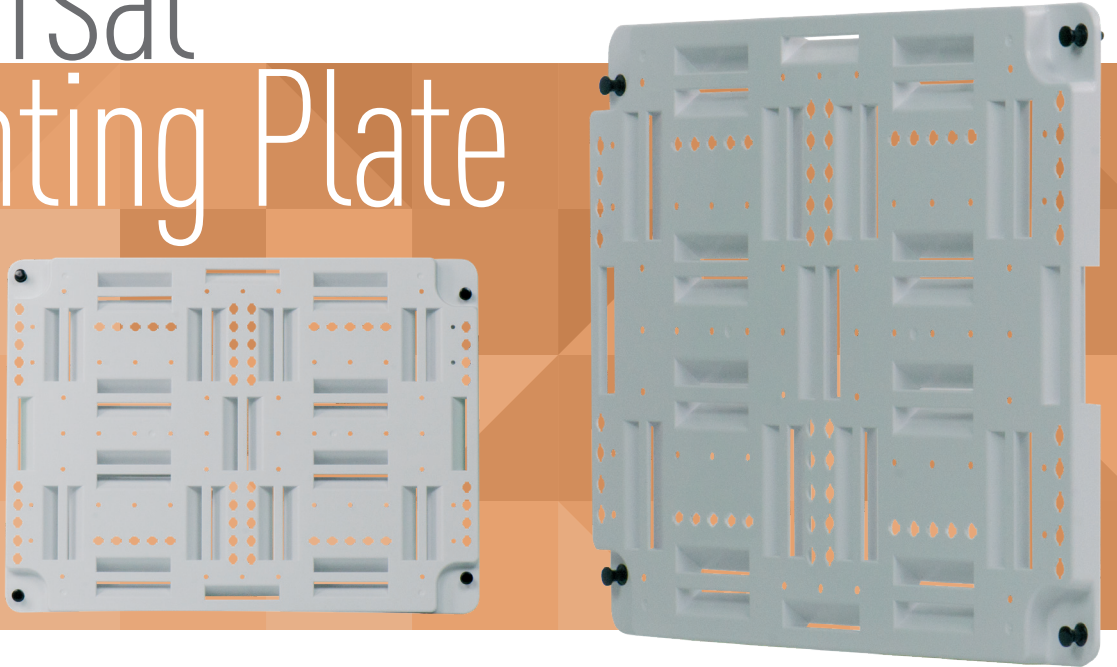

The Universal Mounting Plate is constructed of Wi-Fi transparent ABS Plastic and designed to securely mount a variety of 3rd party devices into the On-Q plastic or metal structured wiring enclosure. It contains vertical and horizontal lancing locations that can be utilized with the 4 feet of included Velcro to strap down large devices like

an ISP Modem / Router. Screw holes are strategically placed throughout for affixing devices like a fiber optic network unit (ONU), cable amplifier or cable splitter. When paired with a Wi-Fi transparent On-Q Plastic Enclosure, wireless devices can easily be secured inside the enclosure without compromising wireless performance.

FEATURES & BENEFITS

- Allows 3rd party wired and wireless devices to be secured within structured wiring enclosure
- Vertical and horizontal lancing locations provide a variety of mounting options
- Strategically placed screw holes allow devices to be securely affixed within enclosure
- Universal mounting holes accept 3rd party modules to maximize compatibility
- Includes (4) plungers and grommets and 4 feet of velcro strapping
- Constructed of durable Wi-Fi transparent ABS Plastic

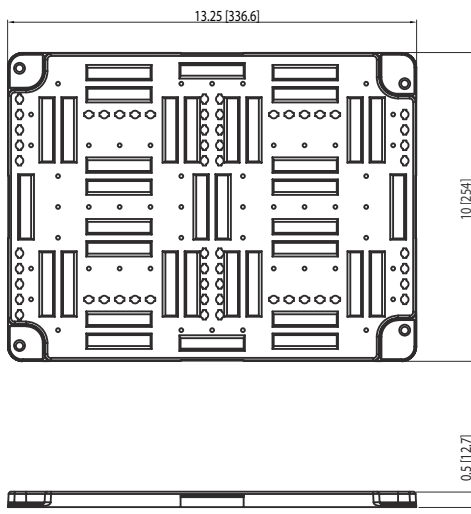



Centralized Distribution for Wired & Wireless Low Voltage Systems

20": ENP2050, ENP2060, ENP2060-5, ENP2080, ENP2080-5

30": ENP3050, ENP3060, ENP3060-5, ENP3080, ENP3080-5

42": ENP4250, ENP4260, ENP4260-5, ENP4280, ENP4280-5

Trim Rings: ENP2001, ENP3001, ENP4201

Accessories: AC1040, AC1041, AC1035-20

This enclosure secures both wired structured wiring systems and wireless networking equipment in a professional, out-of-sight installation.

Order as a complete assembly containing the enclosure and hinged door, a-la-carte, or in bulk to efficiently meet the requirements of your project

Enclosures: Features & Benefits

- **Wireless Transparent Material** – UL-rated ABS plastic allows wireless devices such as access points to secure in the cabinet without degrading network performance.
- **Stackable** – Enclosures and doors are each neatly stackable to efficiently ship and warehouse.
- **Surface or Flush Mounting** – Mounts flush to the stud bay with staggered tabs that allow side-by-side installations of multiple enclosures.
- **UL Rated** – Meets or exceeds the standards of UL Standard 2416. Specified for non-fire rated walls.
- **Universal Mounting Grid** – Compatible with video, voice and data distribution modules from multiple manufacturers. Ask us for our up-to-date compatibility list.
- **Extensive Venting** – Provides superior heat dispersion for powered devices mounted in the enclosure.
- **Extra Depth** – Protruded door adds 1.2" (30mm) of enclosure depth for compatibility with more third party devices such as uninterruptable power supplies (UPS).
- **Conceals Drywall Cutout** – Extended door circumference conceals the drywall cutout for a professional finish.
- **Layered Latch** – Holds the door shut and flush to the drywall without the need of a lock. Locking can be accommodated with the provided screw holes.



Enclosure includes two electrical knockouts on the bottom and five 2" (51mm) cable knockouts on top. 2" rubber grommets are available as an accessory item.

Compliance

- UL 985, Household Fire-Warning System Units. ULC-S545, Residential Fire Warning System Control Units
- UL 1023, Household Burglar-Alarm System Units. CAN/ULC/ORD-C1023, Household Burglar Alarm System Units
- UL 2416, Audio/Video, Information and Communication Technology Equipment Cabinet, Enclosure and Rack Systems
- UL60950-1 & CAN/CSA C22.2 No. 60950-01-07, Information Technology Equipment, Including Electrical Business Equipment
- RoHS Compliant

Technical Information

Enclosure Specifications

	20" Enclosure	30" Enclosure	42" Enclosure
Material	ABS Plastic	ABS Plastic	ABS Plastic
Color	White (Paintable*)	White (Paintable*)	White (Paintable*)
Specified Temperature	32°F - 122°F, 0°C - 50°C	32°F - 122°F, 0°C - 50°C	32°F - 122°F, 0°C - 50°C
Unit Weight	4.5 Lbs 2.04kg	6.17 Lbs 2.8kg (ENP3050)	8.64 Lbs 3.2kg (ENP4250)
Shipping Weight	6.5 Lbs 2.95kg	8.7 Lbs 3.95kg (ENP3050)	12.2 Lbs 5.5 kg (ENP4250)
Paintable*	Rust-Oleum Paint for Plastic or equivalent	Rust-Oleum Paint for Plastic or equivalent	Rust-Oleum Paint for Plastic or equivalent

Dimensions – Enclosures

20" Enclosure

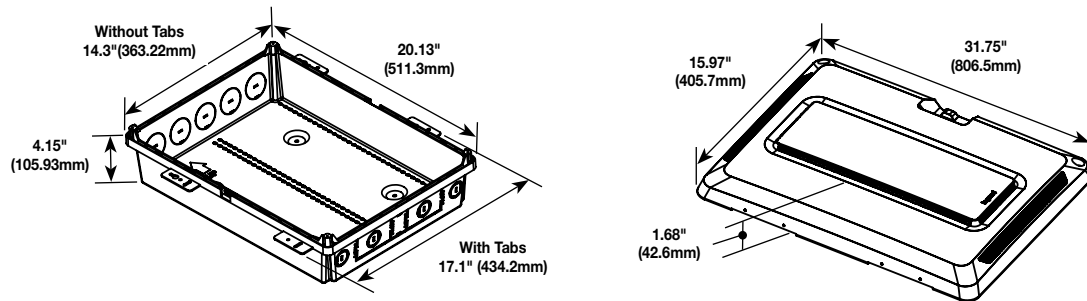

30" Enclosure

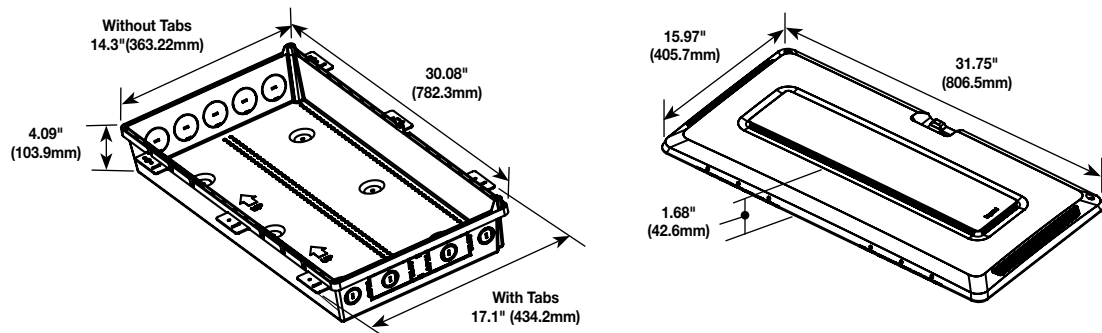

42" Enclosure

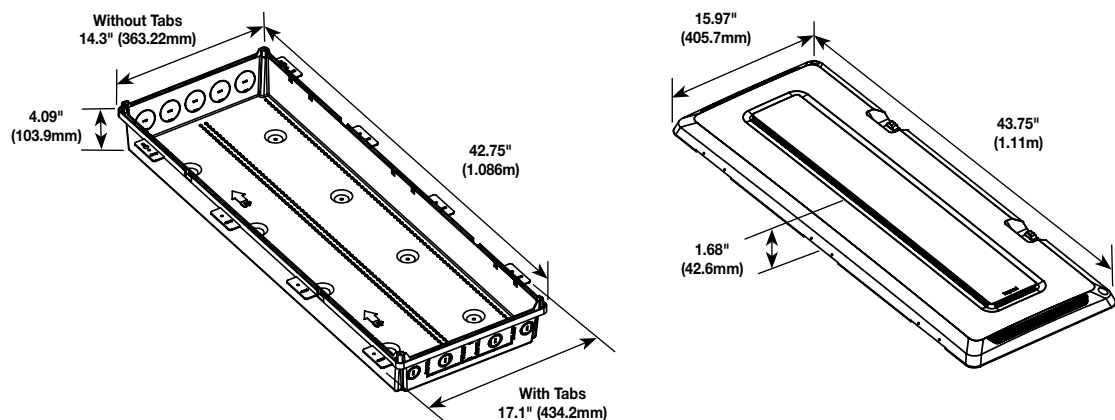

Technical Information

Trim Rings Specifications

	20" Trim Ring	30" Trim Ring	40" Trim Ring
Material	ABS Plastic	ABS Plastic	ABS Plastic
Color	White (Paintable*)	White (Paintable*)	White (Paintable*)
Specified Temperature	32°F - 122°F, 0°C - 50°C	32°F - 122°F, 0°C - 50°C	32°F - 122°F, 0°C - 50°C
Unit Weight	0.5 Lbs 0.227 kg	1 Lb 0.454kg	1 Lb 0.454kg
Shipping Weight	0.5 Lbs 0.227 kg	1 Lb 0.454kg	1 Lb 0.454kg
Paintable*	Rust-Oleum Paint for Plastic or equivalent	Rust-Oleum Paint for Plastic or equivalent	Rust-Oleum Paint for Plastic or equivalent

Dimensions – Trim Rings

ENP2001 – Plastic 20" Trim Ring

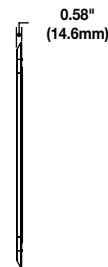
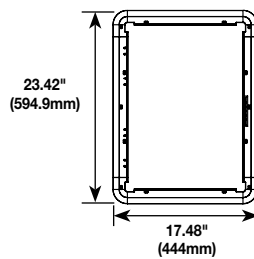
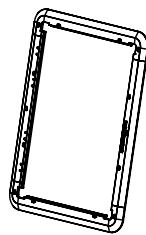

ENP3001 – Plastic 30" Trim Ring

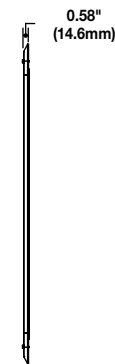
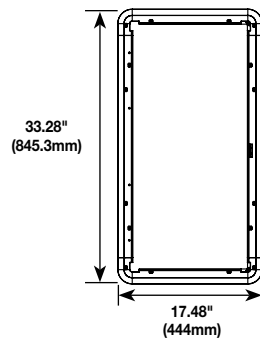
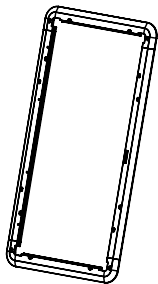

ENP4201 – Plastic 42" Trim Ring

